

SECTION 5

Wind systems components

Mechanical actions parts

Swell shades and tonal boxes

Wood pipe feet

General parts, electric and mechanical

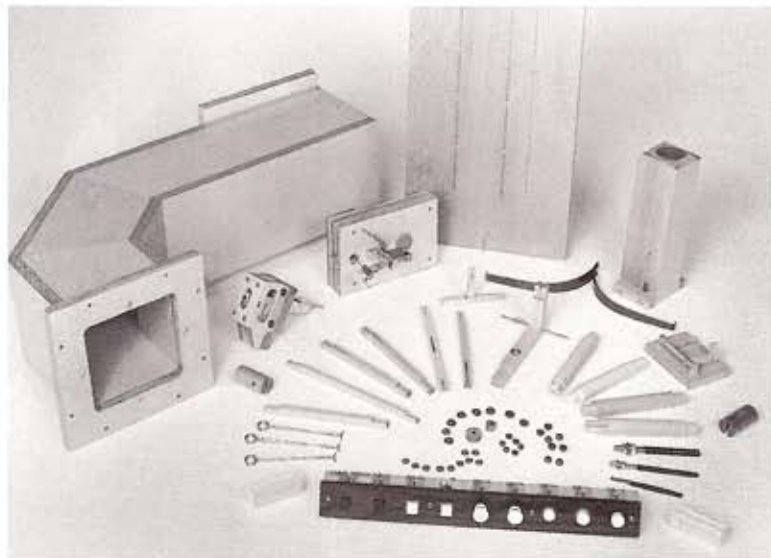

P&S ORGAN SUPPLY COMPANY LTD

WIND SYSTEM COMPONENTS

P&S offer a complete wind system design and manufacture service according to the client's requirements from:

- Traditional 'wedge' leathered bellows system
- Traditional 'double rise' leathered bellows system
- Traditional 'single rise' leathered bellows system
- Modern floating frame bellows system
- Modern 'Schwimmer' wind system

Otherwise, the Organ Builder may choose standard wind component parts including:

- Blower Box Regulator - enclosing the blower, giving a regulated static wind supply
- Wedge Bellows assembly
- Double Rise Bellows
- Single Rise Bellows
- Floating Frame Bellows
- Freestanding Schwimmer Regulator
- Bottom board Schwimmer Regulator
- Curtain Valve internal and external
- Guillotine Valve
- Traditional Tremulant
- Dom Bédos Tremulant
- Schwimmer Regulator Tremulant Pan and Actuator
- Concussion Bellows
- Wood Trunks
- Reservoir Legs
- Pantograph sets

Look in the **Wind Systems Components Section** of the Price List for full details and options available.

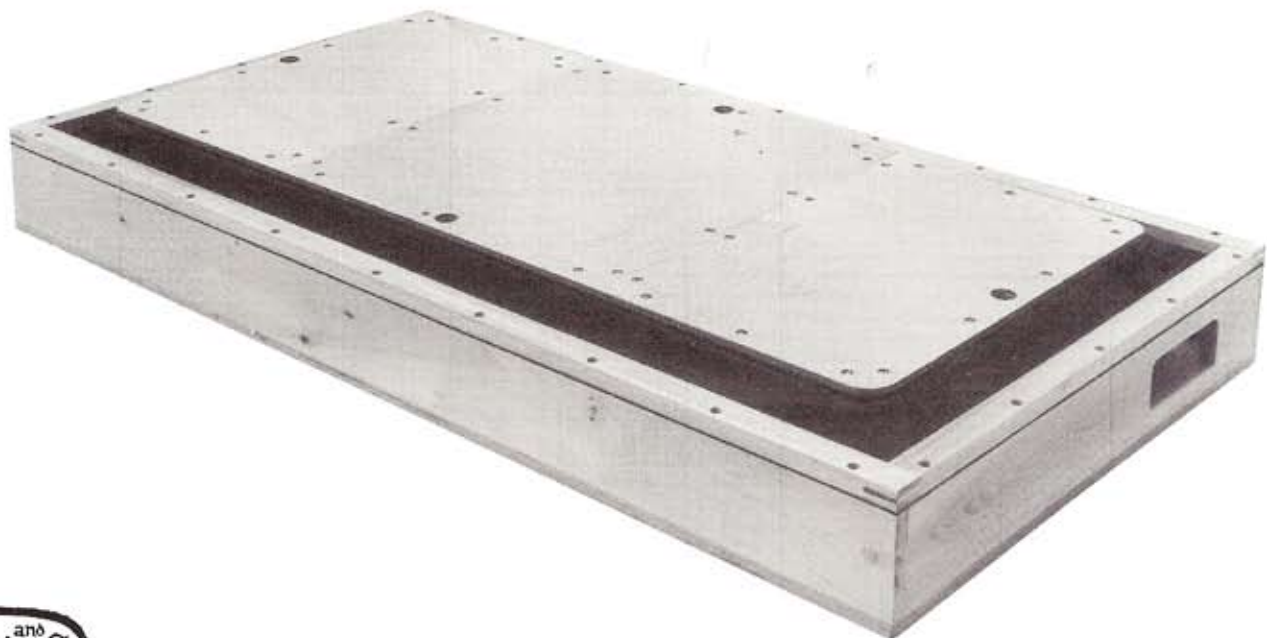

P&S ORGAN SUPPLY COMPANY LTD

WIND SYSTEM COMPONENTS

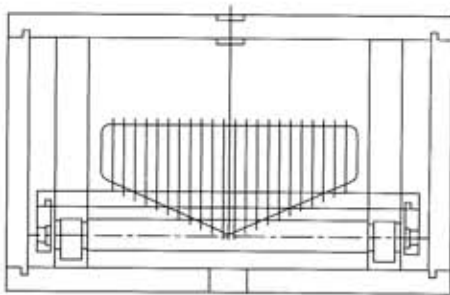
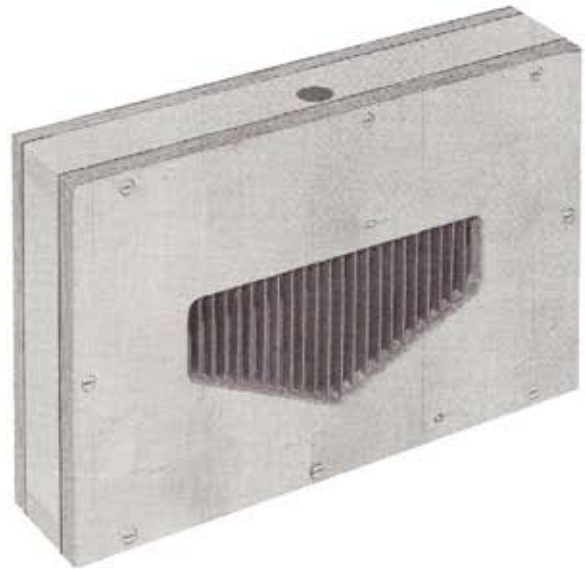

Curtain valve - external (above) and internal (below)

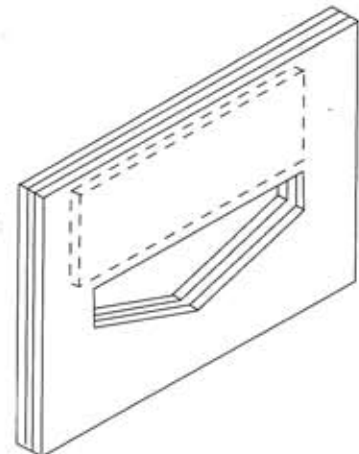
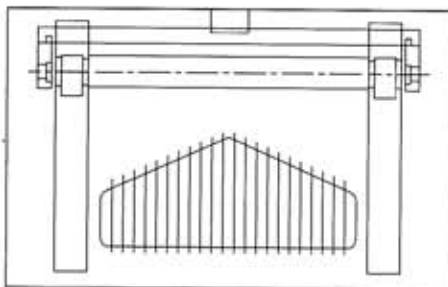

Guillotine valve (sized to requirements)



MECHANICAL ACTION PARTS

P&S offer a complete mechanical action design service for the 'Tracker Builder' together with a supply of materials and sub assemblies as follows:

- Quality wood action small parts including tracker clip connector and roller studs
- Quality small metal parts to complete the wood action part system
- Rollerboards made to order with rollers of aluminium, stainless steel, mild steel or wood
- Tracker material - manual and pedal - Red Cedar
- Square beams made to order
- Roller frames for dividing (pedal) actions to C and C# sides

Look in the **Mechanical Action Parts Section** of the Price List for full details and options available

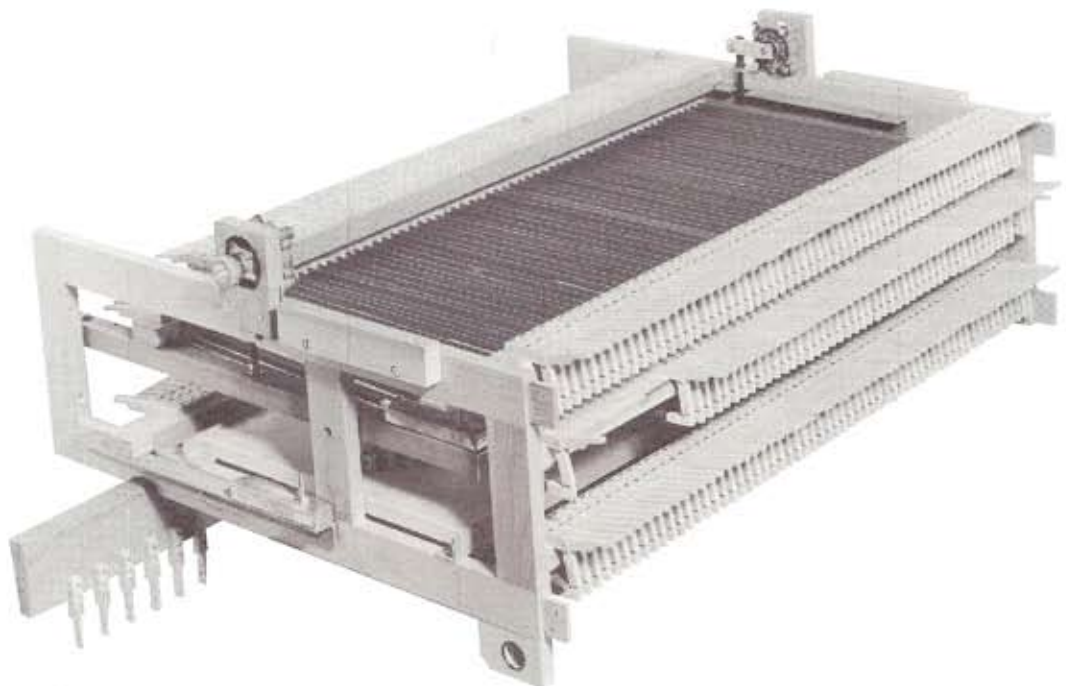
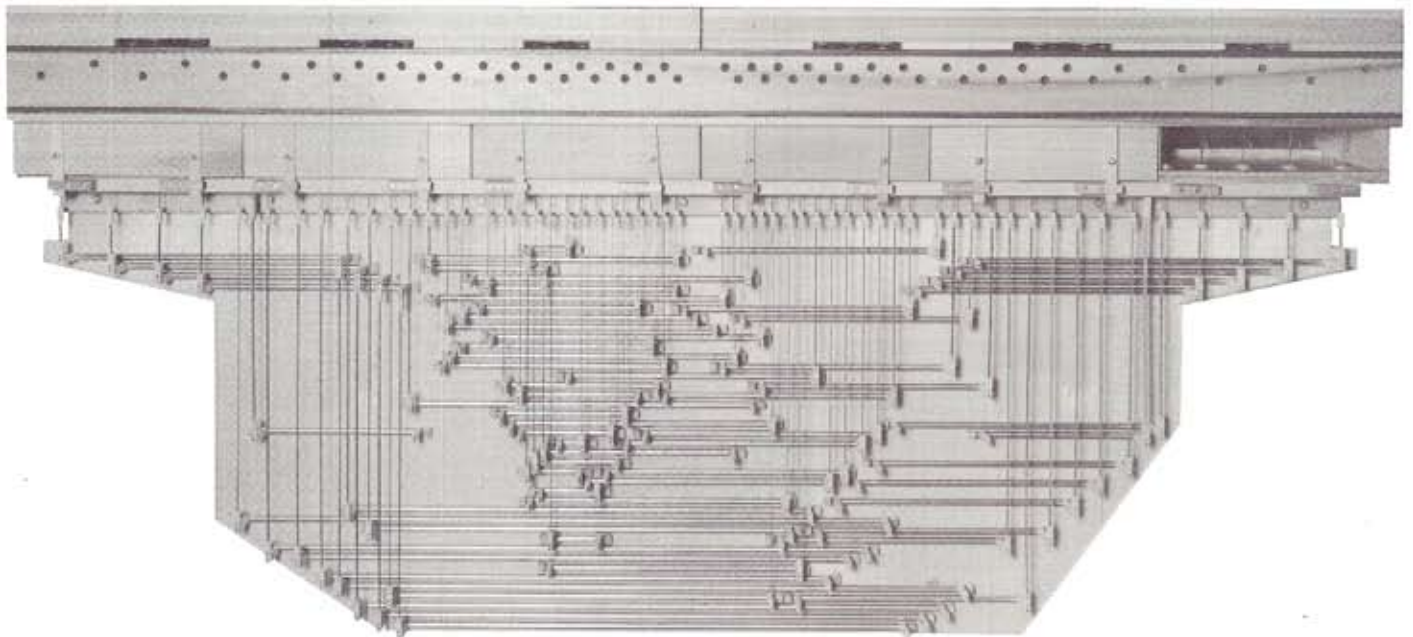

P&S ORGAN SUPPLY COMPANY LTD



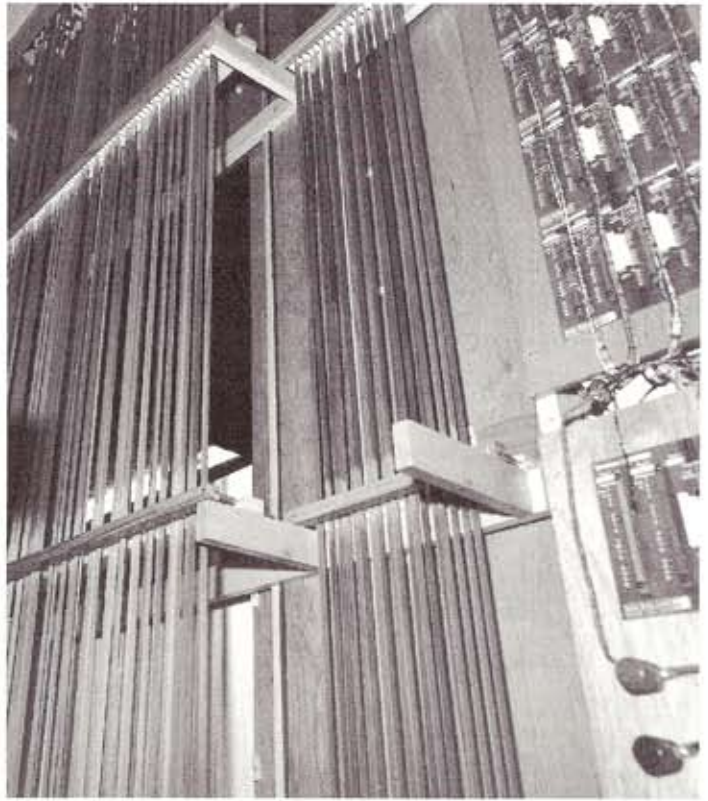
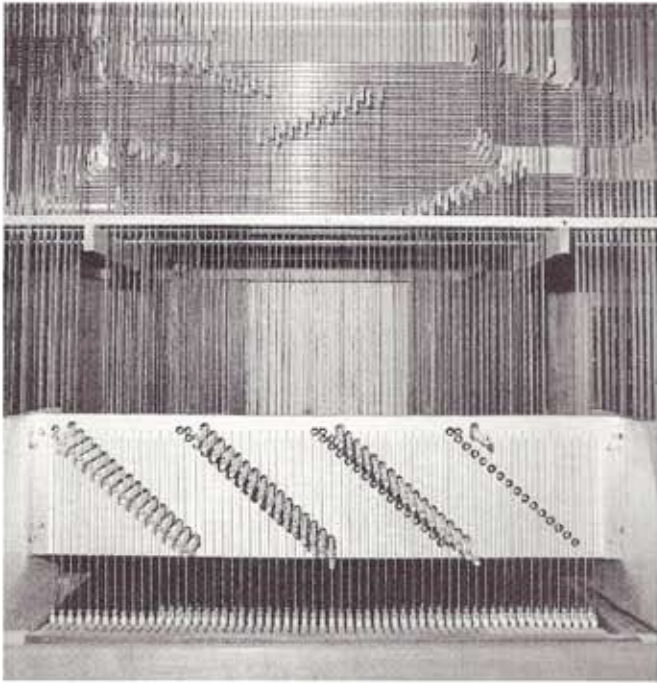

MECHANICAL ACTION PARTS



P&S ORGAN SUPPLY COMPANY LTD

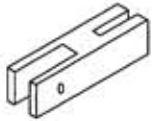
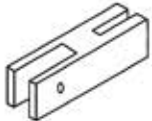
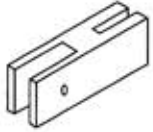
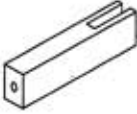
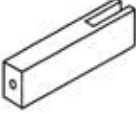
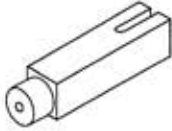
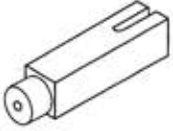
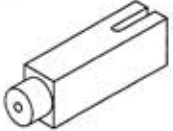
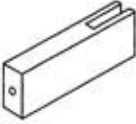
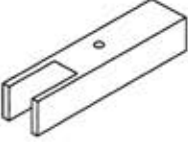
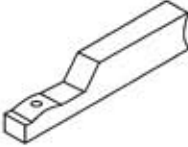
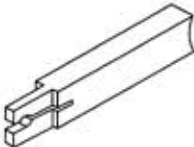

MECHANICAL ACTION PARTS

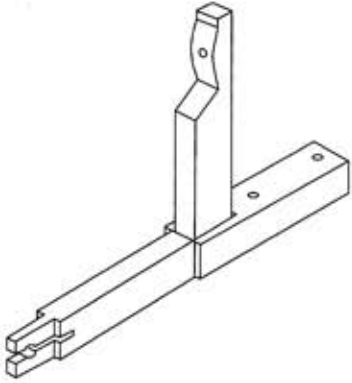
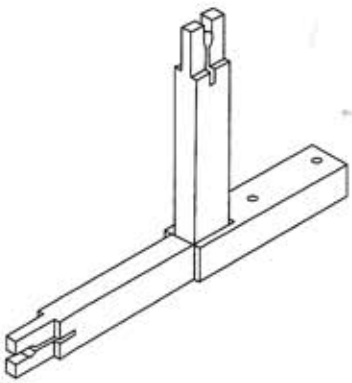
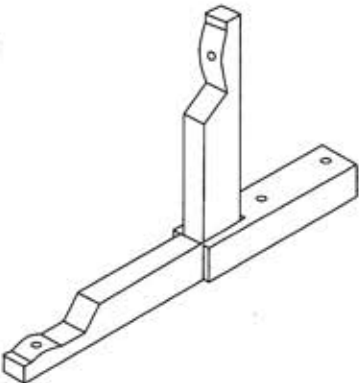
<p>Clip connector manual 0.8mm</p> 	<p>Clip connector manual 1.3mm</p> 	<p>Clip connector pedal 1.8mm</p> 	<p>Wire connector manual 0.8mm</p> 	<p>Wire connector manual 1.3mm</p> 
<p>Detachable connector manual 0.8mm</p> 	<p>Detachable connector manual 1.3mm</p> 	<p>Detachable connector pedal 1.8mm</p> 	<p>Wire connector pedal 1.8mm</p> 	<p>Standard pivot block</p> 
<p>Button roller arm 50mm radius</p> 	<p>Clip roller arm 50mm radius</p> 	<p>Plain wire 16G</p> 	<p>Tapped wire 16G</p> 	<p>Hooked wire 16G</p> 
<p>Squares 50mm radius button/clip</p> 		<p>Squares 50mm radius clip/clip</p> 		<p>Squares 50mm radius button/button</p> 



SWELL BOX AND SHUTTERS (SHADES)

P&S can provide a complete action system from Console to Swell box for either electric or mechanical action. P&S also manufacture expression boxes to client's dimensions. Swell boxes are made of double thickness construction to ensure adequate diminuendo when closed, and are lined with sound reflecting material for maximum projection of sound when open. The shutter front incorporates wide and thick solid wood shutters, running on ball-races for ease of operation from a mechanical expression pedal at the organ console, or swell engine.

P&S supply both a reciprocating electro-pneumatic Swell engine with twelve movements, or an 'infinite gradation' electro-pneumatic engine

with electronic control.

For organs with a built-in console and a detached console, P&S can provide a mechanical system for the attached console with a clutch system that allows the operation of the Swell shutters from the detached console.

Look in the **Swell Box and Shutter (Shades)** Section of the Price List for full details and options available.

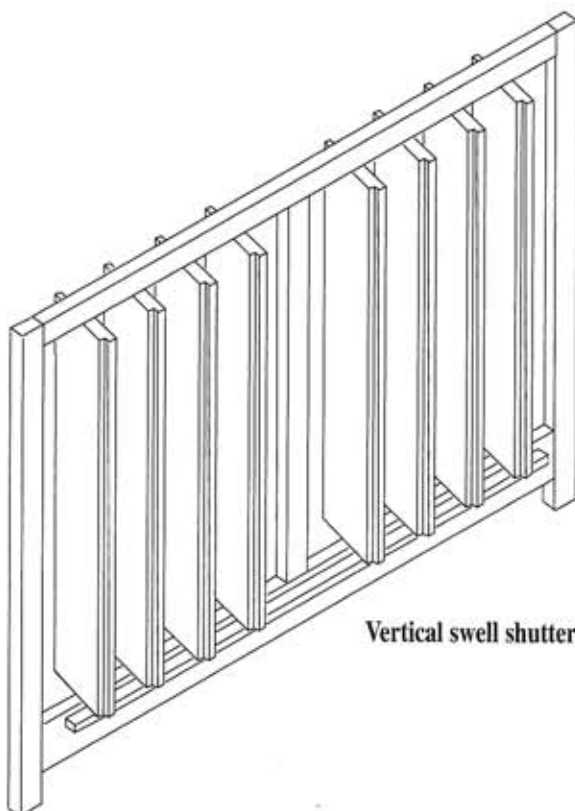
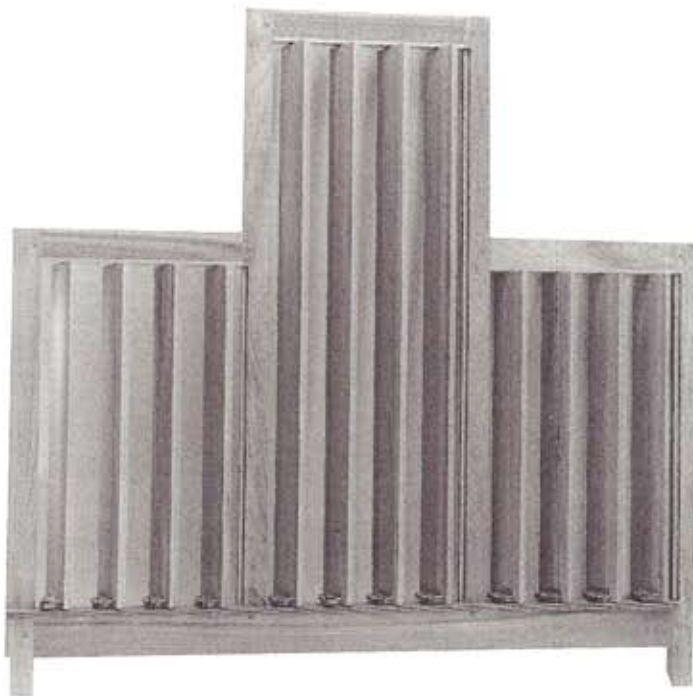
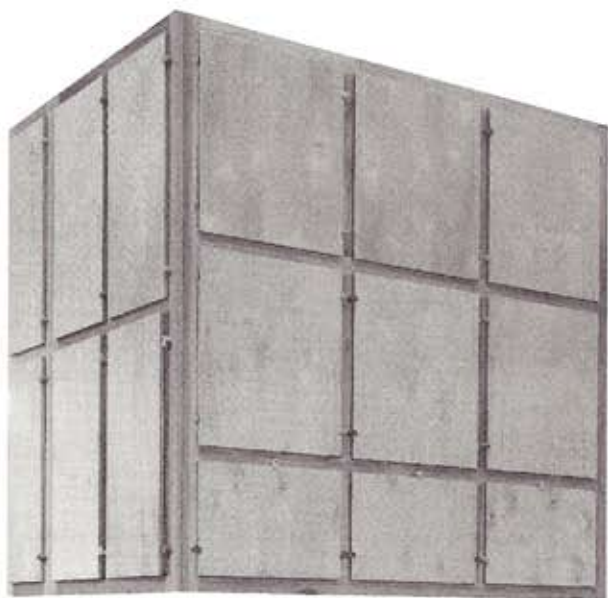

Vertical swell shutters (shades)

Horizontal swell shutter (shades)

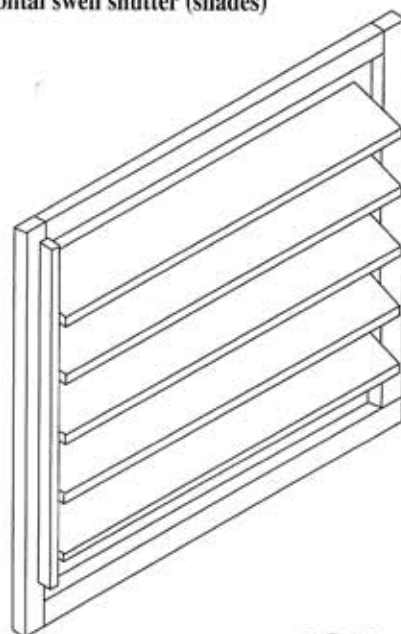

WOOD PIPE FEET AND STOPPER HANDLES

P&S supply pipe feet, stopper handles, and also undertake wood turning to client's specific requirements. Standard pipe feet and stopper handles are supplied in Poplar. Other timbers can be quoted on request.

Look in the **Wood Pipe Feet and Stopper Handle Section** of the Price List for full details and options available.

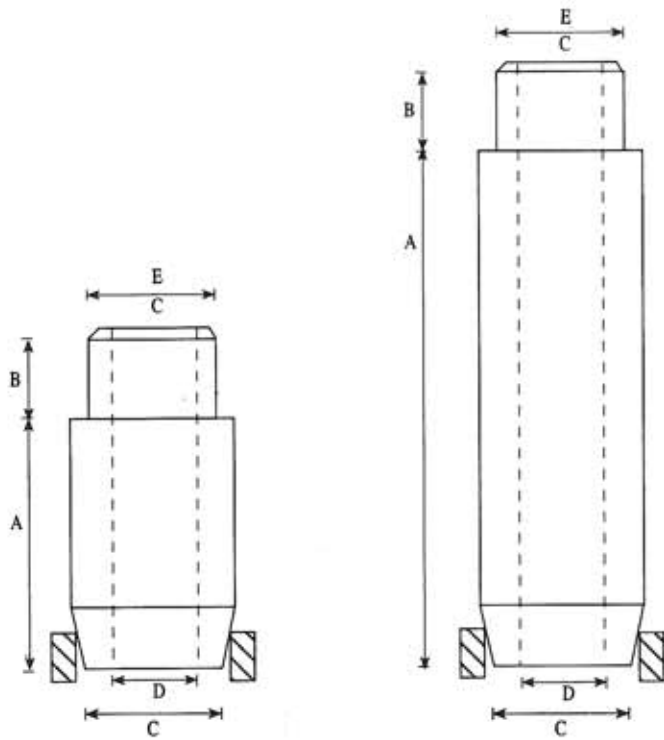

Pipe Feet

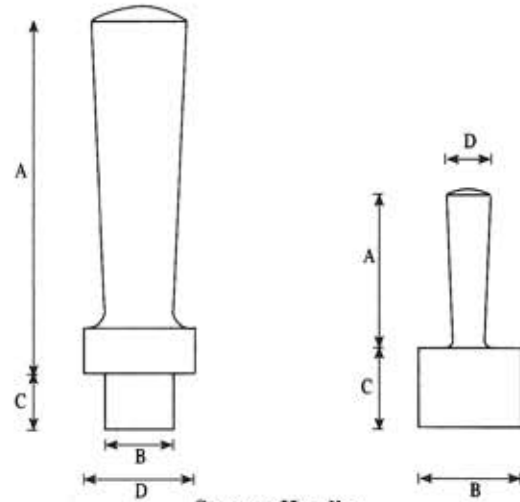

Stopper Handles

PIPE FEET (All dimensions in millimetres)

'Short' Pipe Feet of Poplar, sanded, with one coat of polish.

No.	A	B	C	D	E
000	85	35	105	85	105
00	85	35	90	70	90
0	85	35	75	55	75
1	85	30	62	45	62
2	85	30	50	35	50
3	85	30	42	30	42
4	85	25	35	25	35
5	85	25	28	20	28

'Long' Pipe Feet of Poplar, sanded, with one coat of polish.

No.	A	B	C	D	E
3	170	30	42	30	42
4	170	25	35	25	35
5	170	25	28	20	28
6	170	25	22	17	22
7	170	20	18	12	18
8	170	20	14	9	14
9	170	20	12	7	12
10	170	15	10	6	10
11	170	15	9	5.5	9
12	170	15	8	4.5	8

STOPPER HANDLES (All dimensions in millimetres)

'Long' Stopper Handles of Poplar

No.	A	B	C	D
1	180	30	25	50
2	153	30	25	45
3	131	25	25	40
4	109	22	25	35
5	92	18	25	30
6	75	16	25	25
7	63	14	25	20

'Square' Stopper Handles of Poplar

No.	A	B	C	D
8	50	35	20	17
9	45	27	20	14
10	40	22	20	12
11	35	17	20	9
12	30	13	20	6



P&S ORGAN SUPPLY COMPANY LTD

GENERAL PARTS, ELECTRIC AND MECHANICAL

P&S can supply a range of electric and mechanical parts from tracker nuts through drawstop trundles to complete mechanical stop actions. And on the electrical side from reed switches through pallet, chest and pull down magnets, to slider and drawstop solenoids.

Look in the **General parts** section of the price list for the complete inventory and options available.

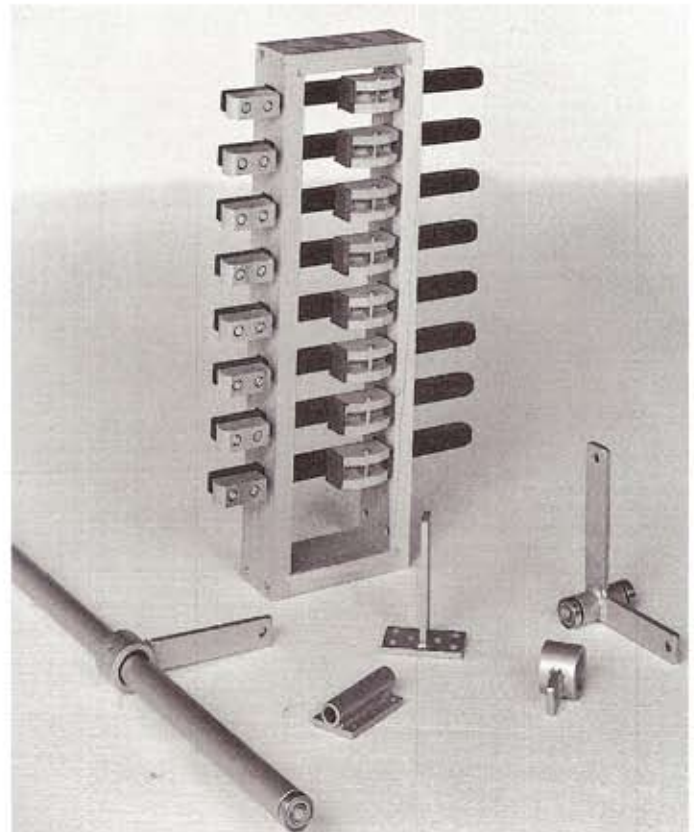
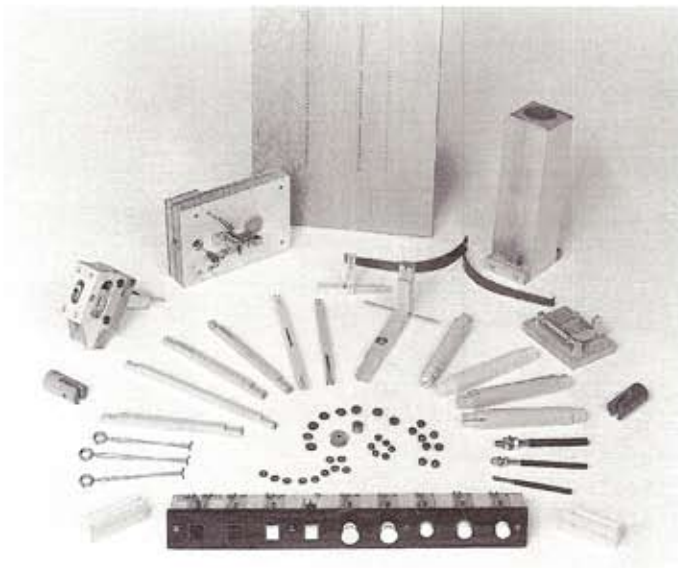
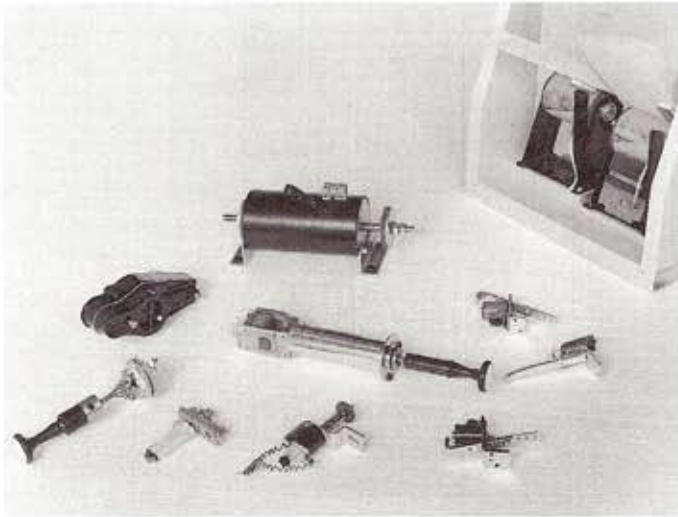

P&S ORGAN SUPPLY COMPANY LTD

